

Pertis



COMPONENTES PARA
VIDRO TEMPERADO

QUALIDADE, FACILIDADE, & REQUINTE

para todos os ambientes!



A VSM, pioneira na fabricação de componentes para vidro temperado no Rio Grande do Sul, fez do estudo do cotidiano do vidraceiro aliado ao uso das mais avançadas tecnologias, seu alicerce para produzir e levar até você qualidade e segurança nos seus produtos.

Nos espelhamos em você, consumidor, para tornar nossos produtos facilitadores do seu trabalho. Somos uma empresa parceira, que não vê apenas números ou nomes, mas pessoas com particularidades, projetos e necessidades especiais a serem atendidas. E para auxiliar o seu trabalho apresentamos nosso catálogo de produtos.

Através das próximas páginas você irá encontrar uma gama completa de perfis, produtos planejados e inspirados no seu dia a dia que buscam aliar facilidade na montagem, beleza nos acabamentos finais e segurança para a sua obra.

VSM, NOSSO COMPROMISSO É COM VOCÊ!

14 anos de história!

Início da nossa história

2009

Abertura da LINEA COLOR

2013

Ampliação da atuação para outros estados

2017

Mudança para um pavilhão maior

2010

Aquisição de pavilhão próprio

2015

Investimento em novas máquinas

2020

Lançamento da linha de kit box e início das atividades das rotas de entrega

2011

Inauguração da unidade de reciclagem de alumínio

2016

Ampliação do parque fabril

2023

Referência	Peso (Kg/Barra 6m)	Milímetro		Polegada	
		A	C	A	C
CT-001	0,500	12,70	1,00	1/2"	-
CT-005	0,600	15,87	1,20	5/8"	-
CT-007	0,890	19,05	1,20	3/4"	-
CT-016	0,980	25,40	1,20	1"	-
CT-047	1,920	38,10	1,58	1.1/2"	1/16"

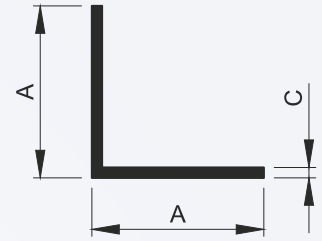

Referência	Peso (Kg/Barra 6m)	Milímetro			Polegada		
		A	B	C	A	B	C
TG-001	0,980	25,40	12,70	0,80	1"	1/2"	1/32"
TG-073	2,100	50,80	25,40	0,80	2"	1"	1/32"
TG-019	5,500	76,20	38,10	1,50	3"	1.1/2"	-
TG-039	7,416	95,00	50,80	1,58	-	2"	1/16"
TG-072	7,760	101,60	50,80	1,58	4"	2"	1/16"
TG-072P	9,648	101,60	50,80	2,00	4"	2"	-
TG-152	15,391	150,00	50,00	2,70	-	-	-

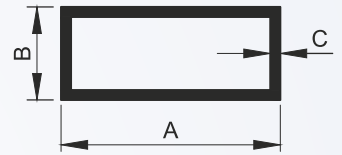

Referência	Peso (Kg/Barra 6m)	Milímetro		Polegada	
		A	C	A	C
TQ-012	3,100	31,75	1,58	1.1/4"	1/16"
TQ-013	2,200	38,10	0,80	1.1/2"	1/32"
TQ-017	4,500	50,80	1,30	2"	-
TQ-017P	6,066	50,80	1,90	2"	-
TQ-020	12,750	101,60	1,80	4"	-

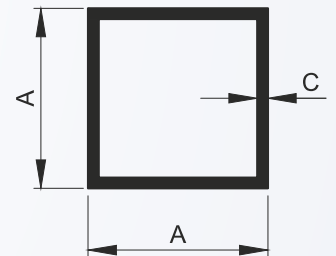

Referência	Peso (Kg/Barra 6m)	Milímetro		Polegada	
		A	B	A	B
TR-014	0,800	15,87	0,80	5/8"	1/32"
TR-018	0,920	19,05	0,80	3/4"	1/32"
TR-040	1,500	25,40	1,20	1"	-
TR-070	3,080	38,10	1,50	1.1/2"	-
TR-098	4,000	50,80	1,58	2"	1/16"

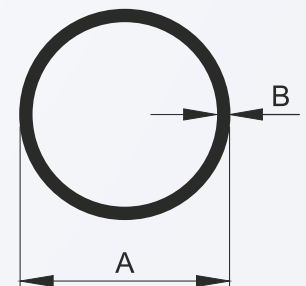

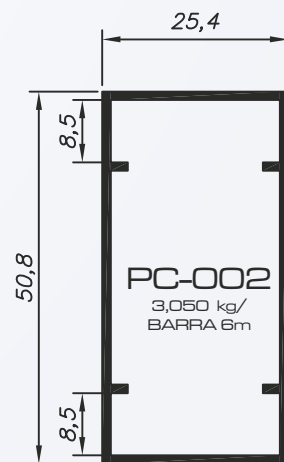
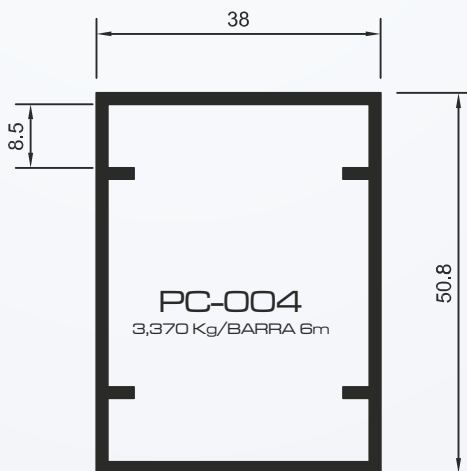
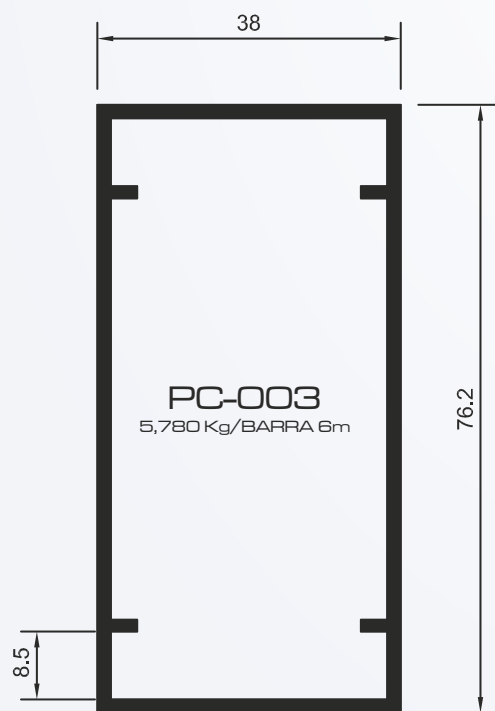
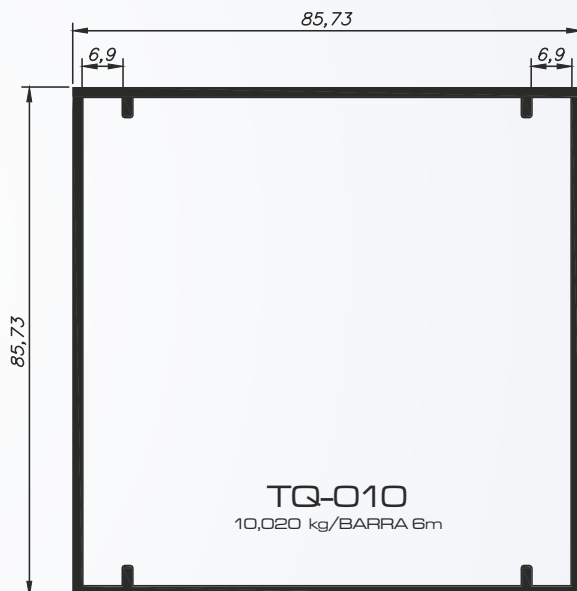
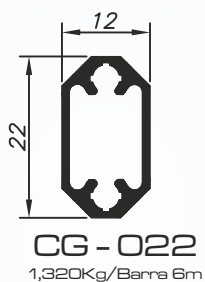
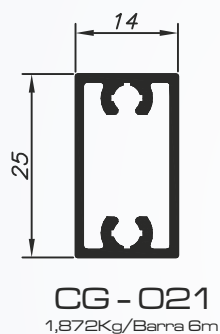
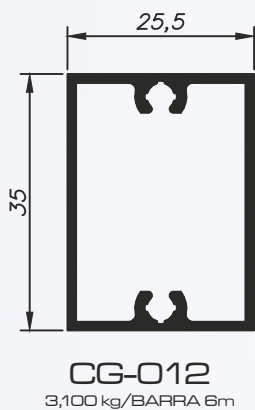
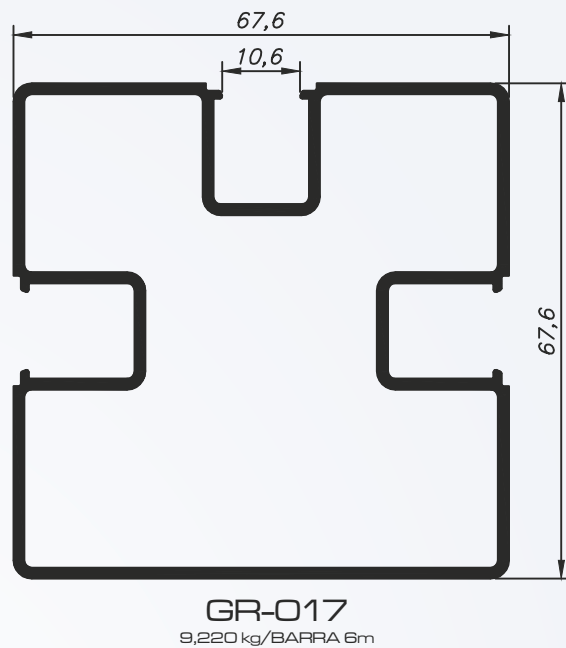
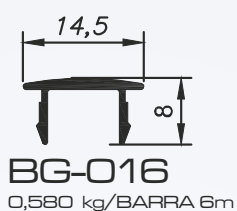
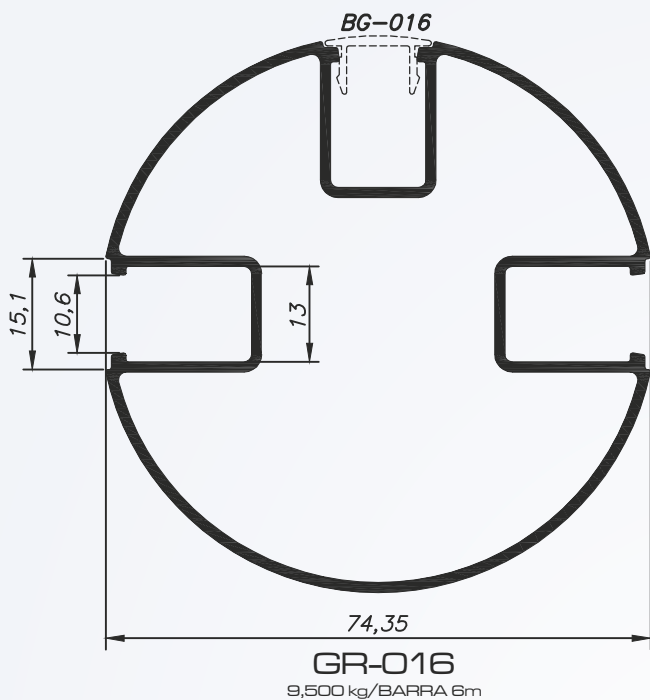

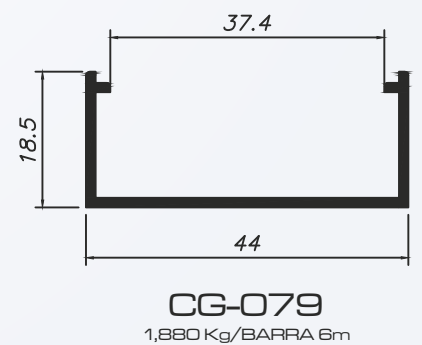
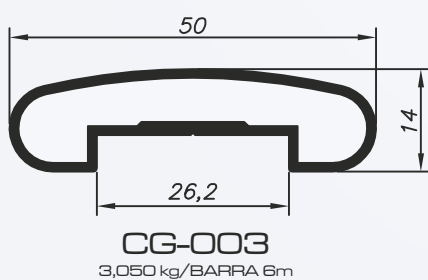
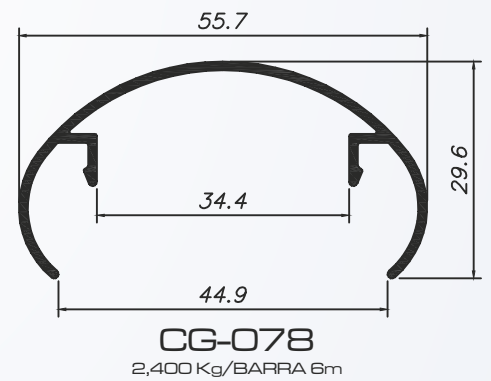
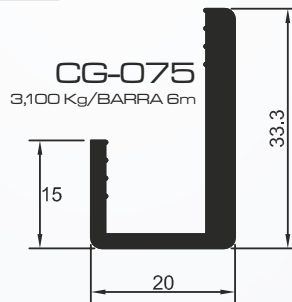
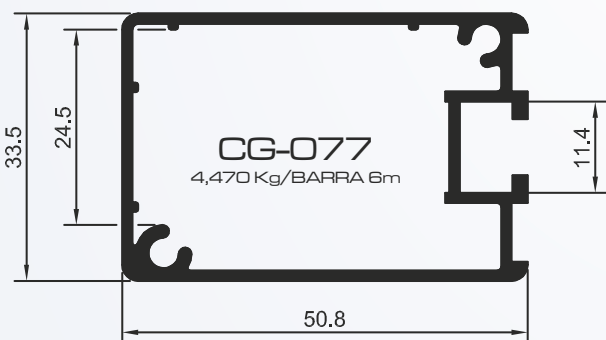
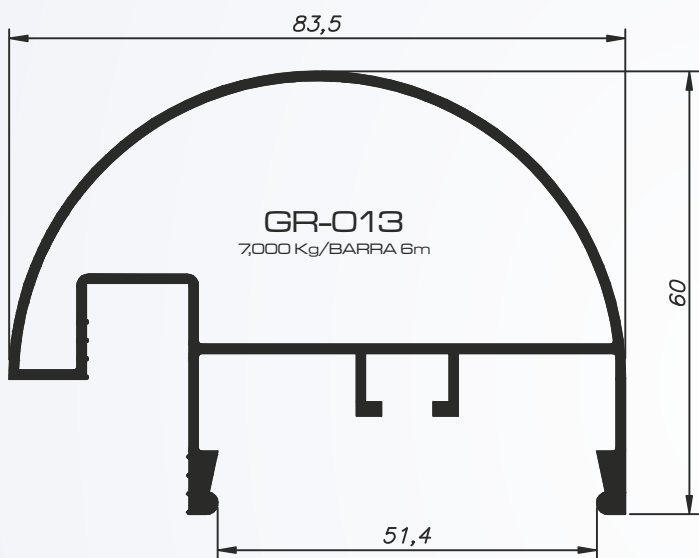
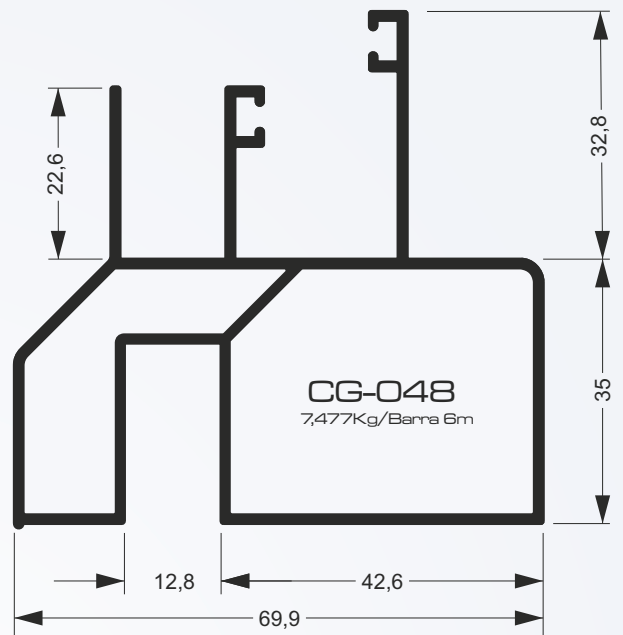
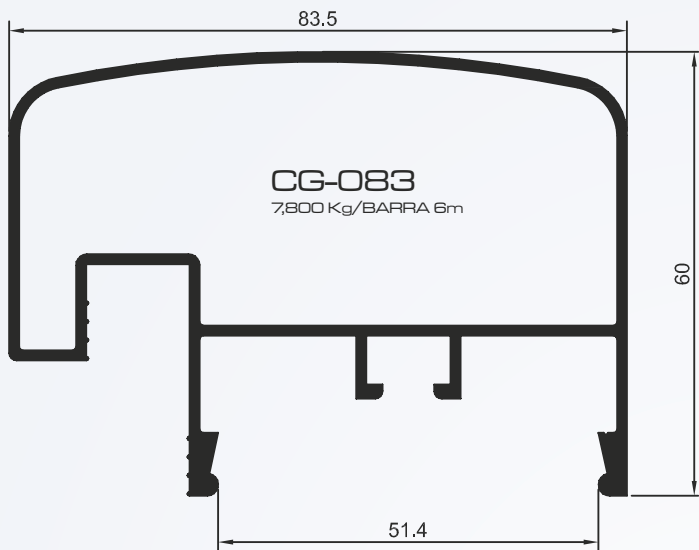

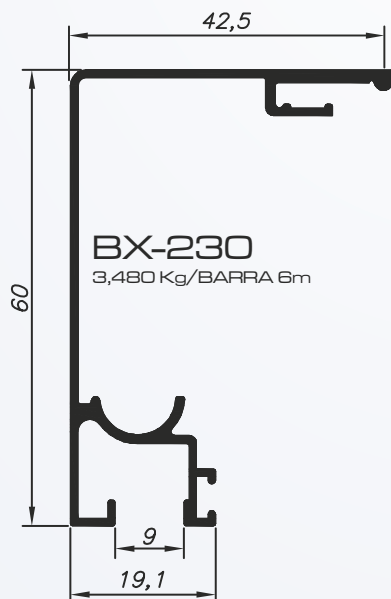
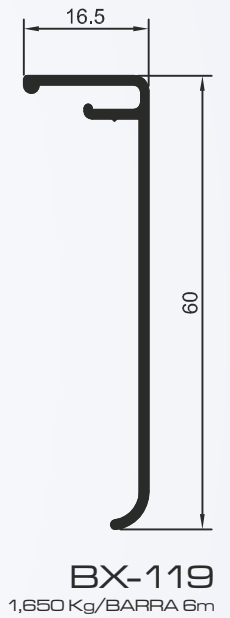
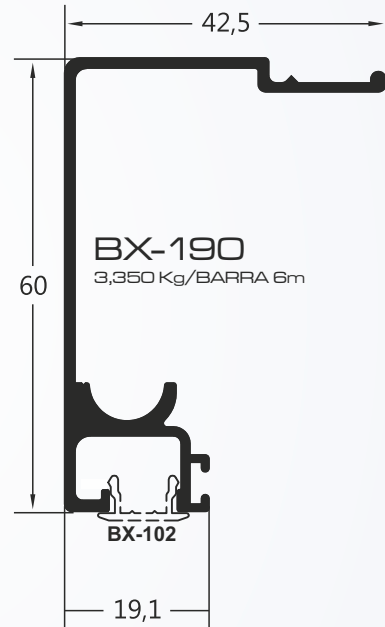
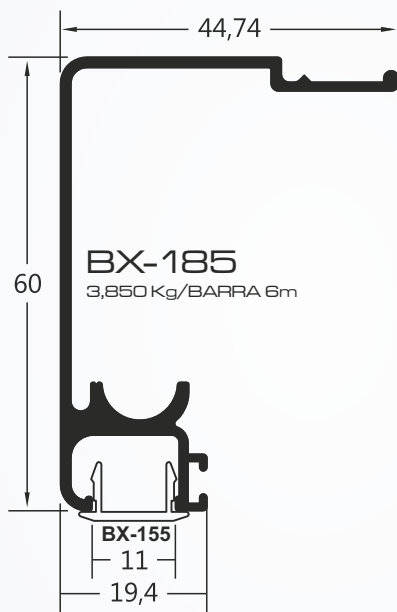
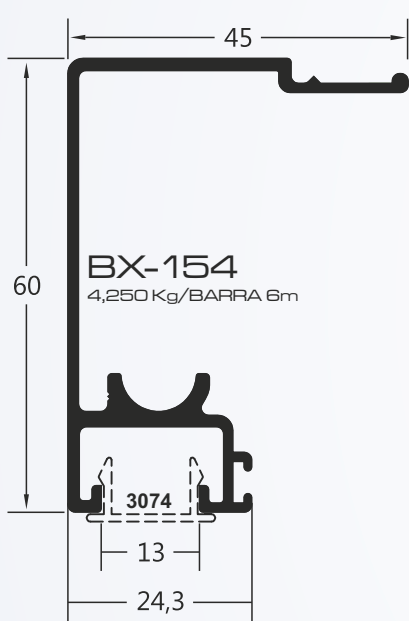
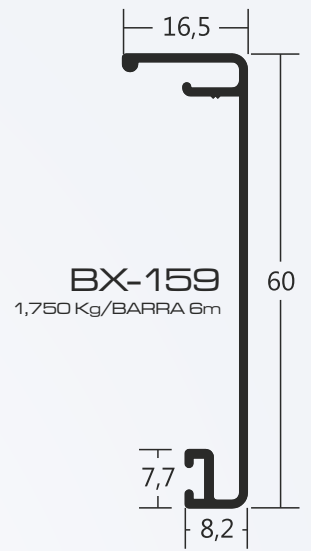
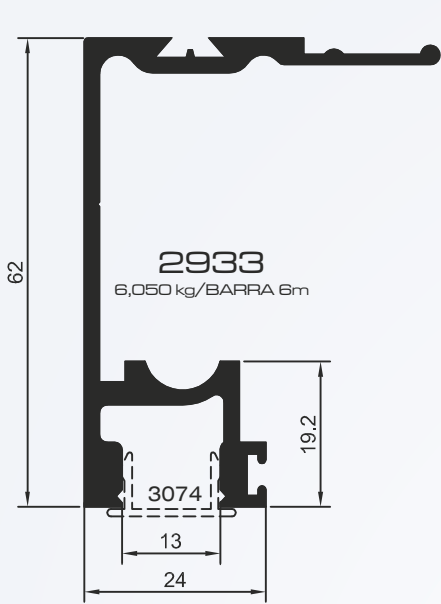

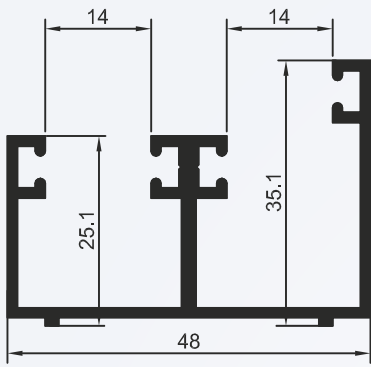

BX-150
3,900 Kg/BARRA 6m

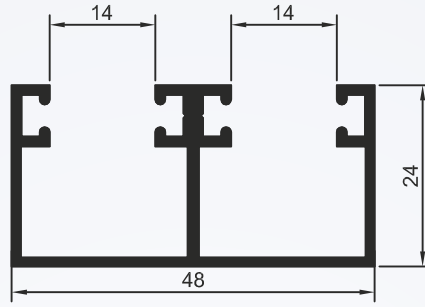

BX-170
3,240 Kg/BARRA 6m

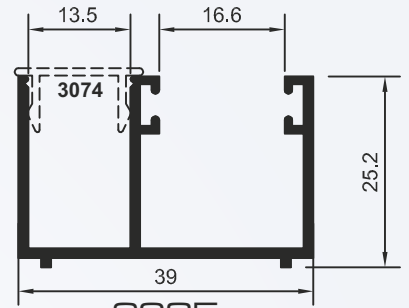

2935
2,380Kg/BARRA 6m

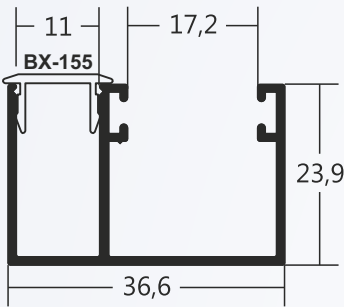

BX-155
2,150 Kg/BARRA 6m

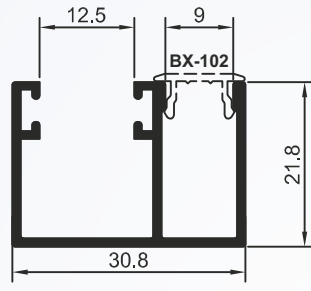

BX-102
1,950 Kg/BARRA 6m

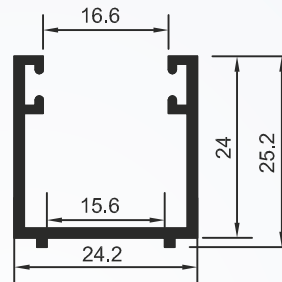

2936
1,750 Kg/BARRA 6m

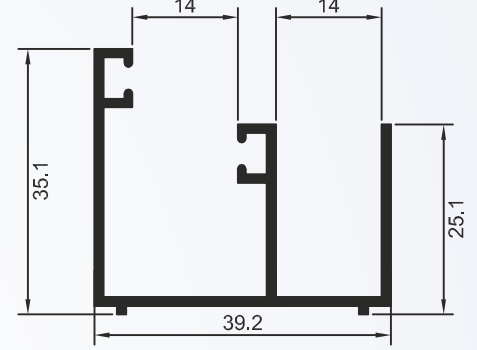

BX-141
2,690 Kg/BARRA 6m

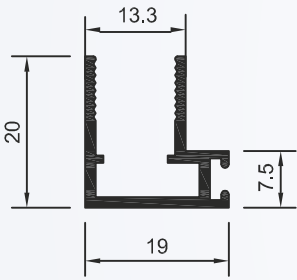

2937
1,170 Kg/BARRA 6m

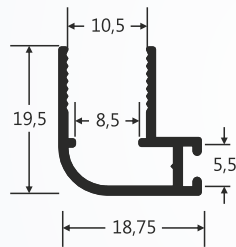

BX-251
1,070 Kg/BARRA 6m

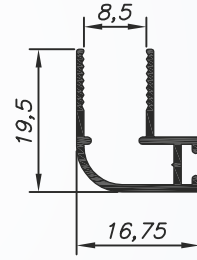

BX-271
1,040 kg/BARRA 6m

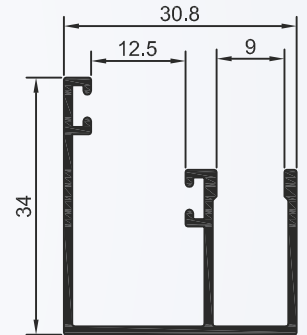

BX-214
2,190 Kg/BARRA 6m

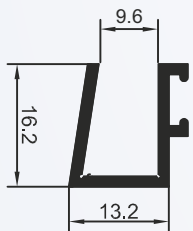

3172
0,850 Kg/BARRA 6m

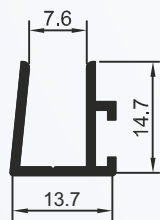

BX-128
0,850 Kg/BARRA 6m

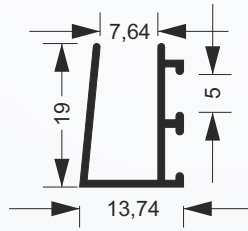

BX-127
0,924 kg/BARRA 6m

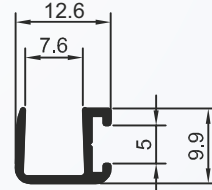

BX-126
0,600 Kg/BARRA 6m

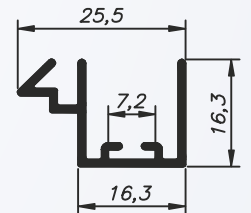

DS-1391
1,310 Kg/BARRA 6m

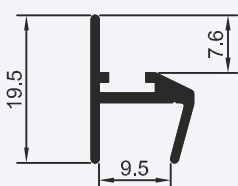

BX-131
0,900 Kg/BARRA 6m

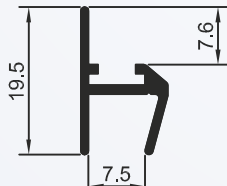

BX-130
0,800 Kg/BARRA 6m

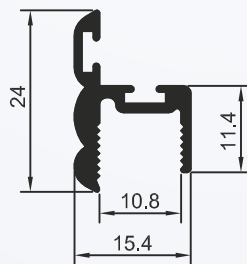

BX-209
1,500 Kg/BARRA 6m

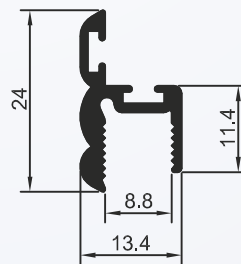

BX-261
1,390 Kg/BARRA 6m

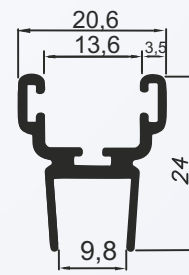

BX-133
1,716 kg/BARRA 6m

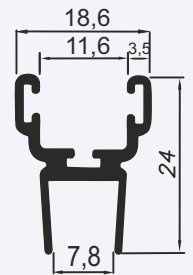

BX-132
1,570 kg/BARRA 6m

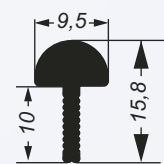
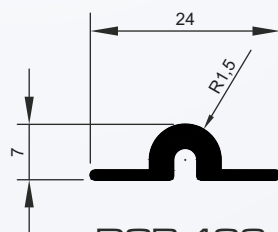
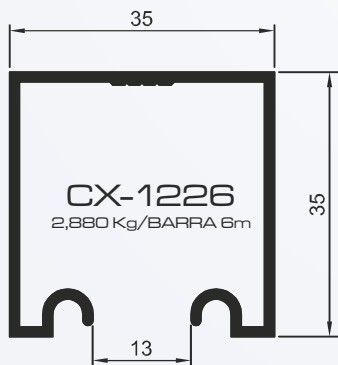
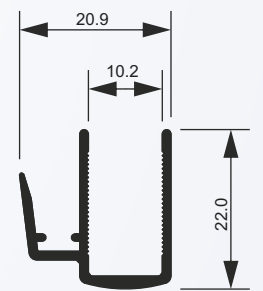
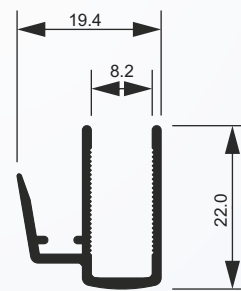
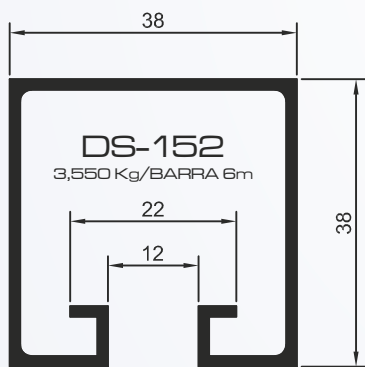
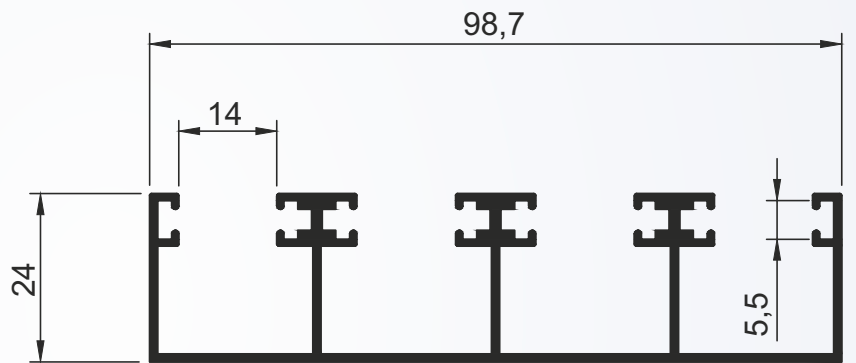
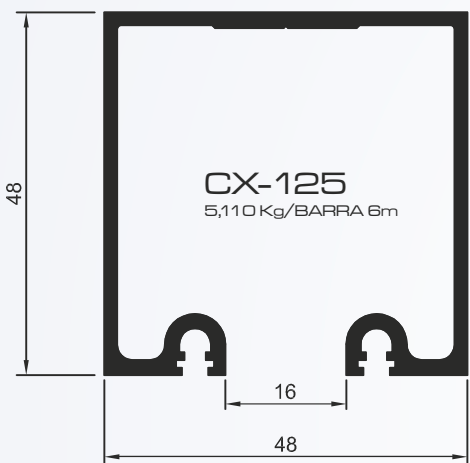
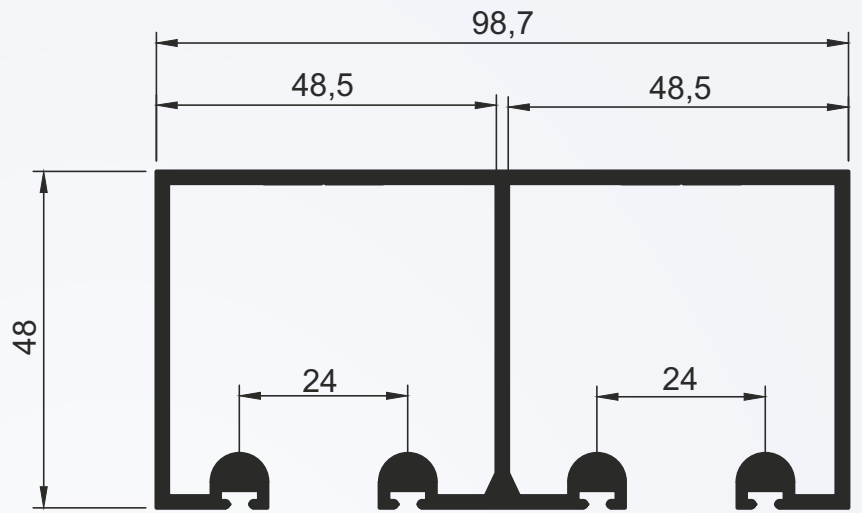
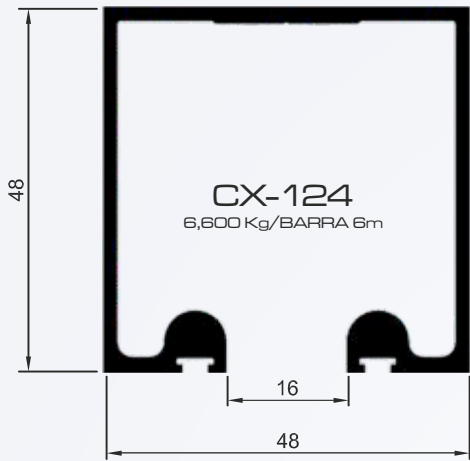

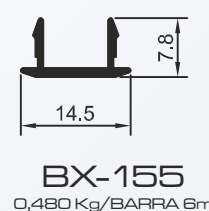
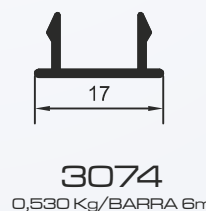
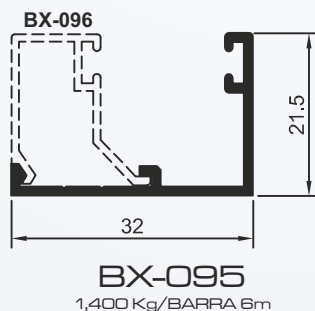
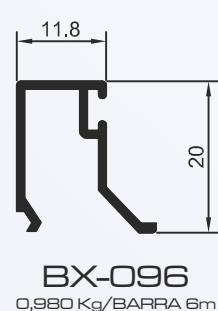
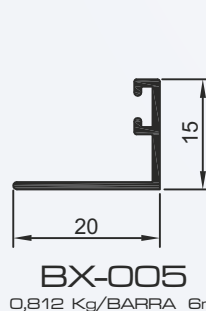
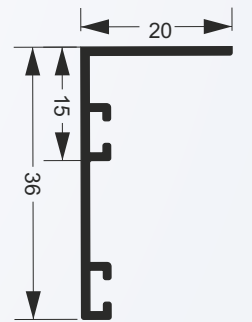
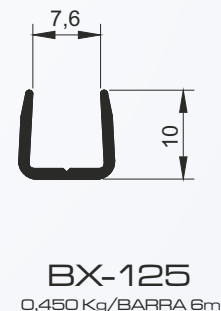
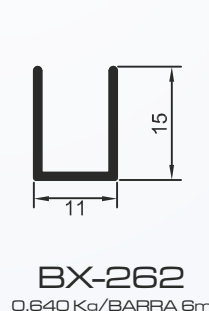
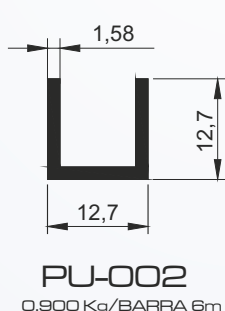
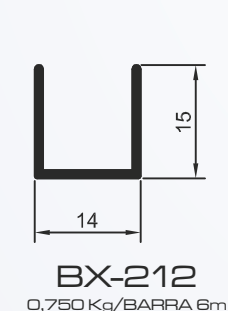
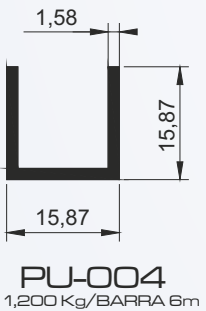
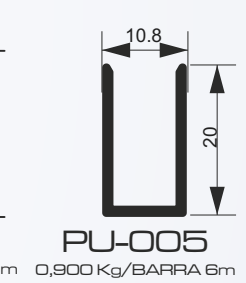
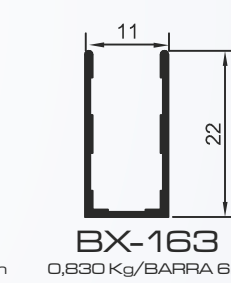
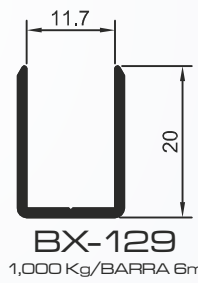
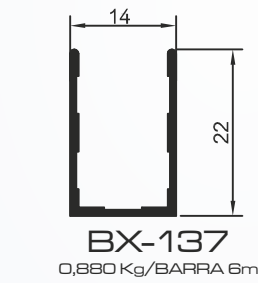
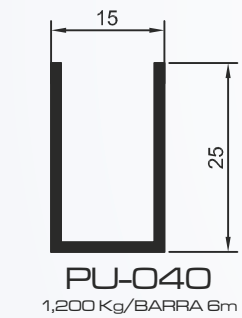
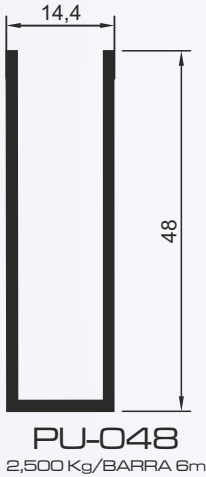
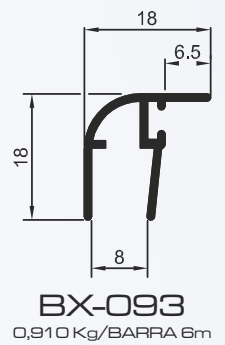
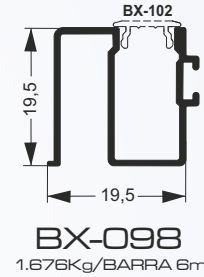
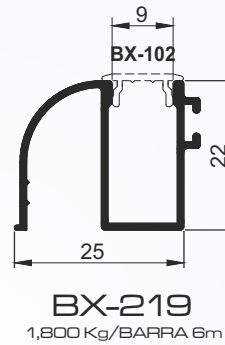
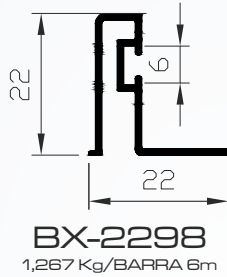
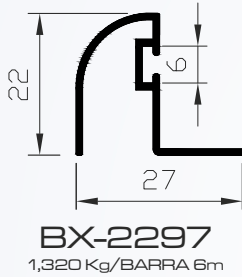
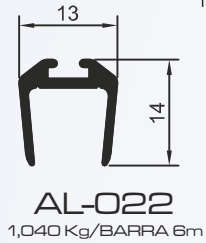
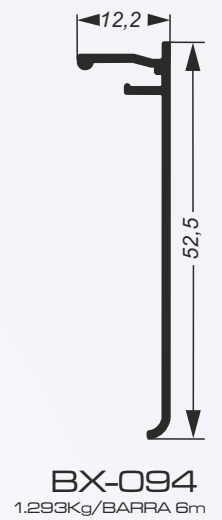
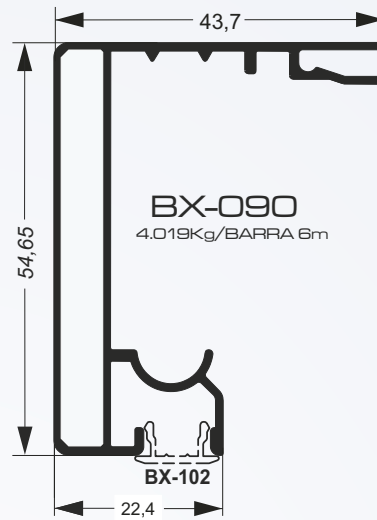
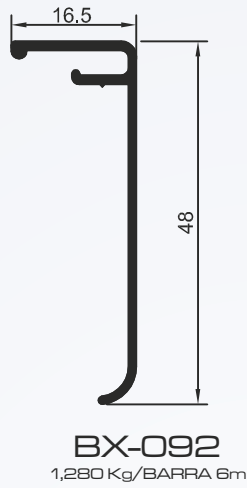
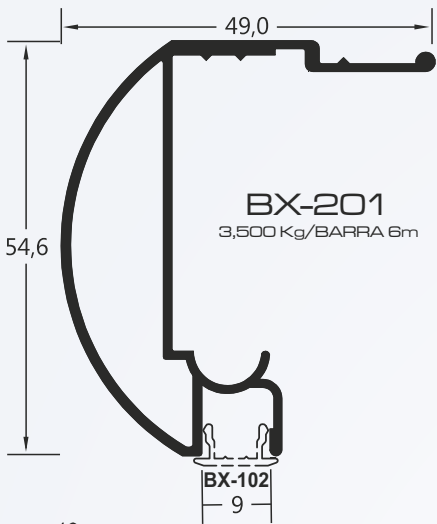

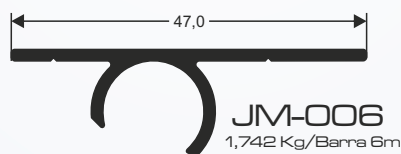
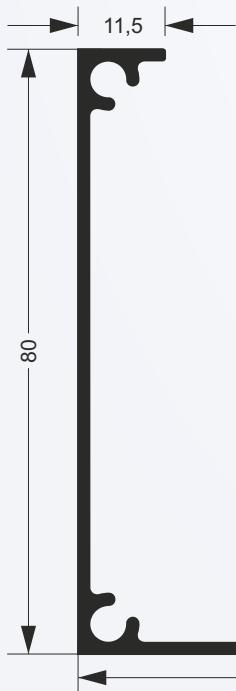
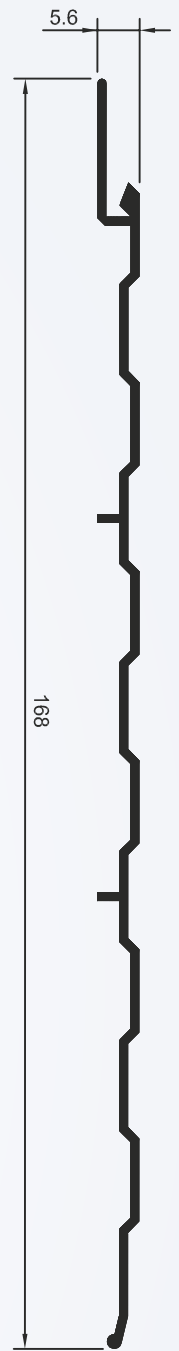
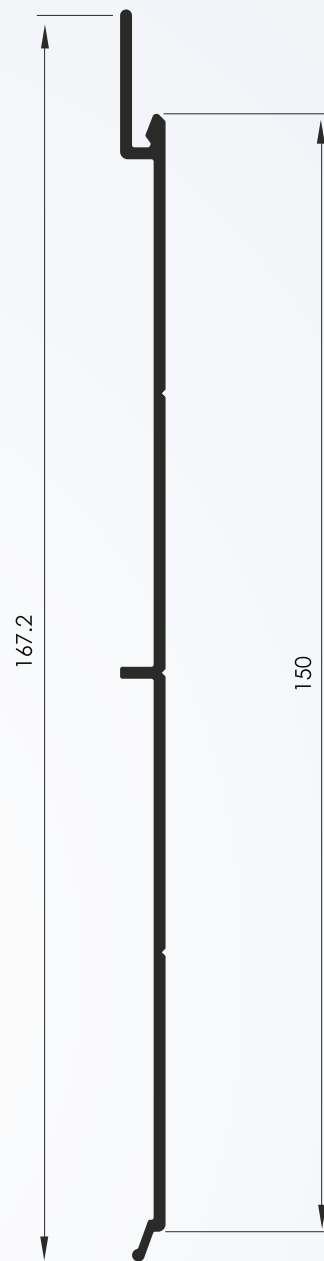
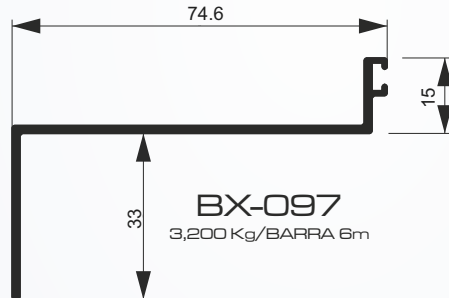
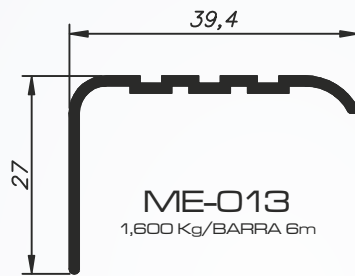
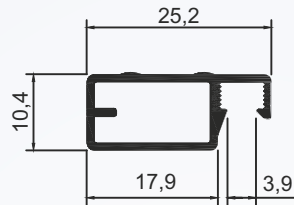
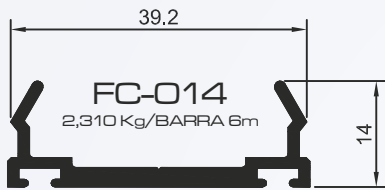
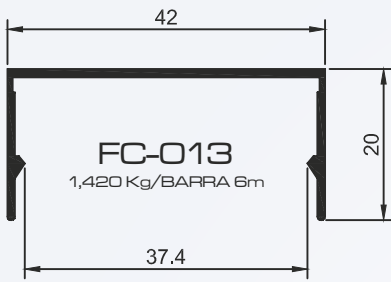

Calha
JM-005
6,917 Kg/BARRA 6m

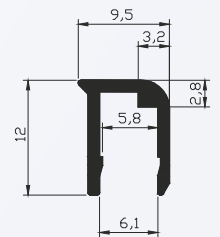
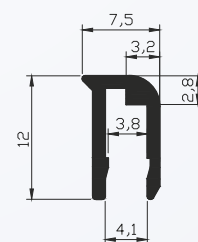
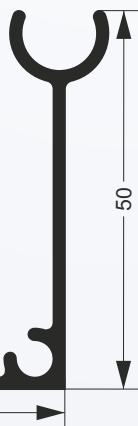

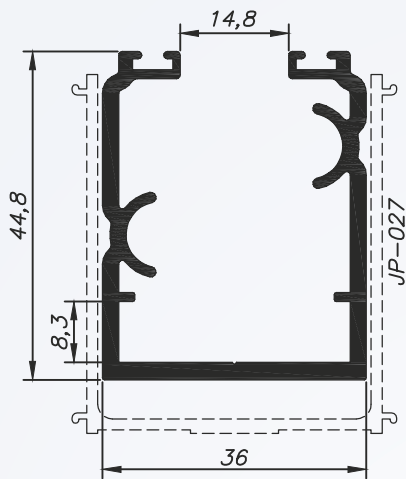

JP-025
5,480 Kg/BARRA 6m

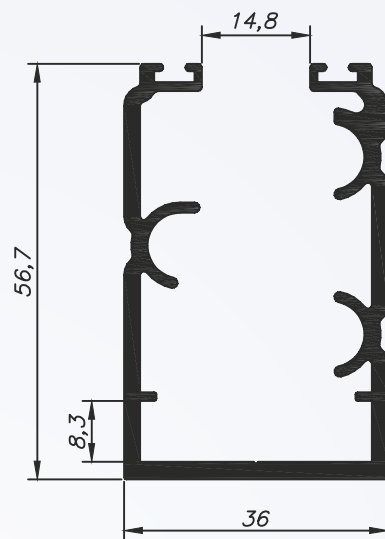

JP-026
6,800 Kg/BARRA 6m

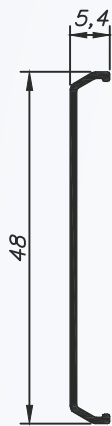

JP-028
0,860 Kg/BARRA 6m

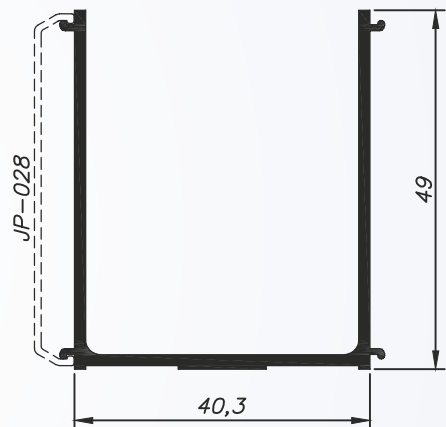

JP-027
3,740 Kg/BARRA 6m

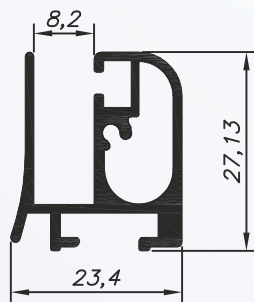

JP-083
2,970 Kg/BARRA 6m

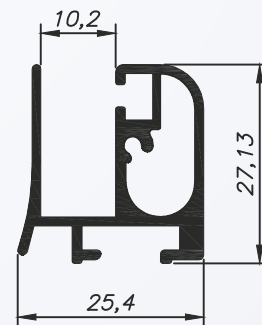

JP-084
2,910 Kg/BARRA 6m



VSM COMPONENTES PARA
VIDRO TEMPERADO



VSM Ferragens



(54) 99667-0251



www.vsm.ind.br